



Features

- Six or eight channels of EMI filtering with integrated ESD protection
- Pi-style EMI filters in a capacitor-resistor-capacitor (C-R-C) network
- $\pm 15\text{kV}$ ESD protection on each channel (IEC 61000-4-2 Level 4, contact discharge)
- $\pm 30\text{kV}$ ESD protection on each channel (HBM)
- Greater than -35dB attenuation (typical) at 1 GHz
- TDFN package with 0.50mm lead pitch:
 - 6-ch. = 12-lead TDFN
 - 8-ch. = 16-lead TDFN
- Tiny TDFN package size:
 - 12-lead: 3.0mm x 1.35mm
 - 16-lead: 4.0mm x 1.60mm
- Increased robustness against vertical impacts during manufacturing process
- RoHS-compliant, lead-free finishing

Applications

- LCD and Camera data lines in mobile handsets
- I/O port protection for mobile handsets, notebook computers, PDAs etc.
- EMI filtering for data ports in cell phones, PDAs or notebook computers.
- Wireless handsets
- Handheld PCs/PDAs
- LCD and camera modules

Product Description

The CM1409 is a family of pi-style EMI filter arrays with ESD protection, which integrates either six or eight filters (C-R-C) in a small form factor, TDFN 0.50mm pitch package. The CM1409 has component values of 15pF-100 Ω -15pF per channel. The CM1409 has a cut-off frequency of 110MHz and can be used in applications with data rates up to 44Mbps. The parts include ESD diodes on every pin, which provide a very high level of protection for sensitive electronic components against electrostatic discharge (ESD). The ESD protected diodes safely dissipate ESD strikes of $\pm 15\text{kV}$, which even exceeds the maximum requirement of the IEC61000-4-2 international standard. Using the MIL-STD-883 (Method 3015) specification for Human Body Model (HBM) ESD, the pins are protected for contact discharges at greater than $\pm 30\text{kV}$.

These devices are particularly well-suited for portable electronics (e.g. wireless handsets, PDAs, notebook computers) because of their small package and easy-to-use pin assignments. In particular, the CM1409 is ideal for EMI filtering and protecting data and control lines for the I/O data ports, LCD display and camera interface in mobile handsets.

The CM1409 is housed in space-saving, low-profile 12- and 16-lead TDFN packages with a 0.50mm pitch, RoHS-compliant, lead-free finishing.

Block Diagram

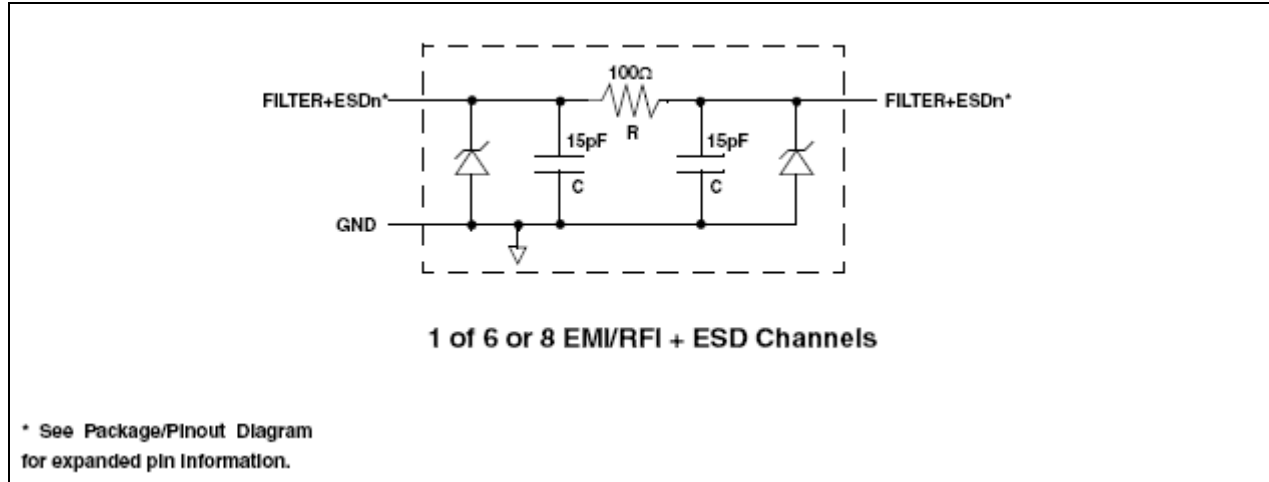

PACKAGE / PINOUT DIAGRAMS

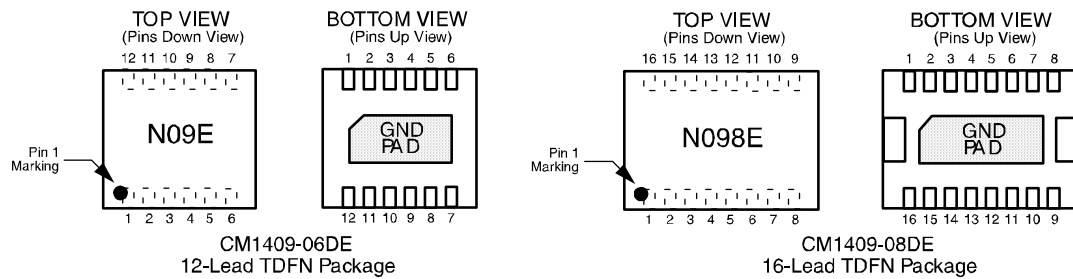

Note:
 1) These drawings are not to scale.

CM1409

PIN DESCRIPTIONS

DEVICE PIN(s)		NAME	DESCRIPTION	DEVICE PIN(s)		NAME	DESCRIPTION
-06	-08			-06	-08		
1	1	FILTER1	Filter + ESD Channel 1	12	16	FILTER1	Filter + ESD Channel 1
2	2	FILTER2	Filter + ESD Channel 2	11	15	FILTER2	Filter + ESD Channel 2
3	3	FILTER3	Filter + ESD Channel 3	10	14	FILTER3	Filter + ESD Channel 3
4	4	FILTER4	Filter + ESD Channel 4	9	13	FILTER4	Filter + ESD Channel 4
5	5	FILTER5	Filter + ESD Channel 5	8	12	FILTER5	Filter + ESD Channel 5
6	6	FILTER6	Filter + ESD Channel 6	7	11	FILTER6	Filter + ESD Channel 6
	7	FILTER7	Filter + ESD Channel 7		10	FILTER7	Filter + ESD Channel 7
	8	FILTER8	Filter + ESD Channel 8		9	FILTER8	Filter + ESD Channel 8
GND PAD		GND	Device Ground				

Ordering Information

PART NUMBERING INFORMATION

Pins	Package	Lead-free Finish	
		Ordering Part Number ¹	Part Marking
12	TDFN-12	CM1409-06DE	N09E
16	TDFN-16	CM1409-08DE	N098E

Note 1: Parts are shipped in Tape & Reel form unless otherwise specified.

Specifications

ABSOLUTE MAXIMUM RATINGS

PARAMETER	RATING	UNITS
Storage Temperature Range	-65 to +150	°C
DC Power per Resistor	100	mW
DC Package Power Rating	500	mW

STANDARD OPERATING CONDITIONS

PARAMETER	RATING	UNITS
Operating Temperature Range	-40 to +85	°C

ELECTRICAL OPERATING CHARACTERISTICS (SEE NOTE1)

SYMBOL	PARAMETER	CONDITIONS	MIN	TYP	MAX	UNITS
R	Resistance		80	100	120	Ω
C _{TOTAL}	Total Channel Capacitance	At 2.5VDC Reverse Bias, 1MHz, 30mVAC	24	30	36	pF
C	Capacitance C ₁	At 2.5VDC Reverse Bias, 1MHz, 30mVAC		15		pF
V _{DIODE}	Standoff Voltage	I _{DIODE} =10 μ A		6.0		V
I _{LEAK}	Diode Leakage Current (reverse bias)	V _{DIODE} = 3.3V		0.1	1.0	μ A
V _{SIG}	Signal Clamp Voltage Positive Clamp Negative Clamp	I _{LOAD} = 10mA I _{LOAD} = -10mA	5.6 -1.5	6.8 -0.8	9.0 -0.4	V V
V _{ESD}	In-system ESD Withstand Voltage a) Human Body Model, MIL-STD-883, Method 3015 b) Contact Discharge per IEC 61000-4-2 Level 4	Note 2	\pm 30 \pm 15			kV kV
R _{DYN}	Dynamic Resistance Positive Negative			2.3 0.9		Ω Ω
f _c	Cut-off Frequency Z _{SOURCE} =50 Ω , Z _{LOAD} =50 Ω	Channel R = 100 Ω , Channel C = 15pF		110		MHz
A _{1GHz}	Absolute Attenuation @ 1GHz from 0dB Level	Z _{SOURCE} = 50 Ω , Z _{LOAD} = 50 Ω , DC Bias = 0V; Notes 1 and 3		35		dB
A _{800MHz - 6GHz}	Absolute Attenuation @ 800MHz to 6GHz from 0dB Level	Z _{SOURCE} = 50 Ω , Z _{LOAD} = 50 Ω , DC Bias = 0V; Notes 1 and 3		30		dB

Note 1: T_A=25°C unless otherwise specified.

Note 2: ESD applied to input and output pins with respect to GND, one at a time.

Note 3: Attenuation / RF curves characterized by a network analyzer using microprobes.

Performance Information

Typical Filter Performance ($T_A=25^\circ\text{C}$, DC Bias=0V, 50 Ohm Environment)

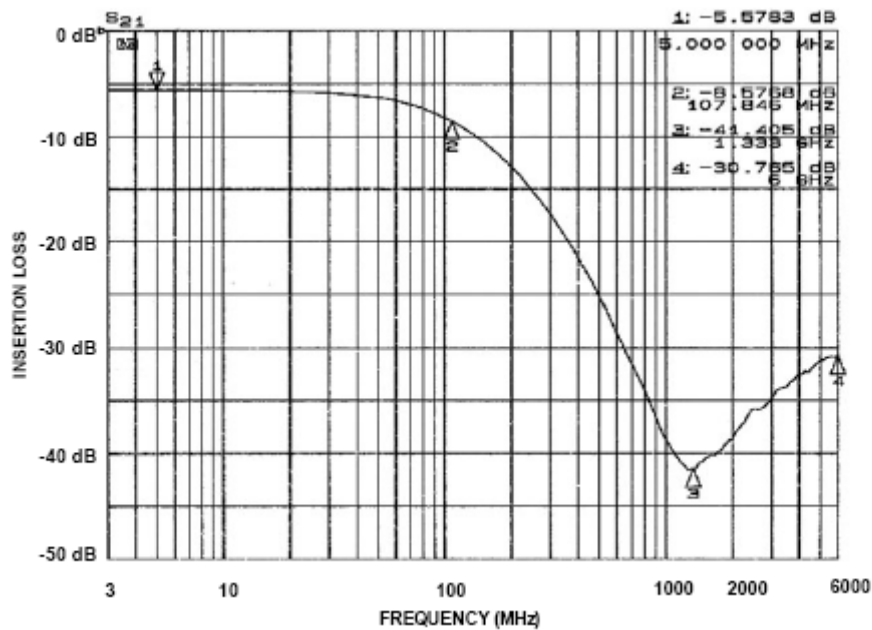

Figure 1. Insertion Loss vs. Frequency (FILTER1 Input to GND)

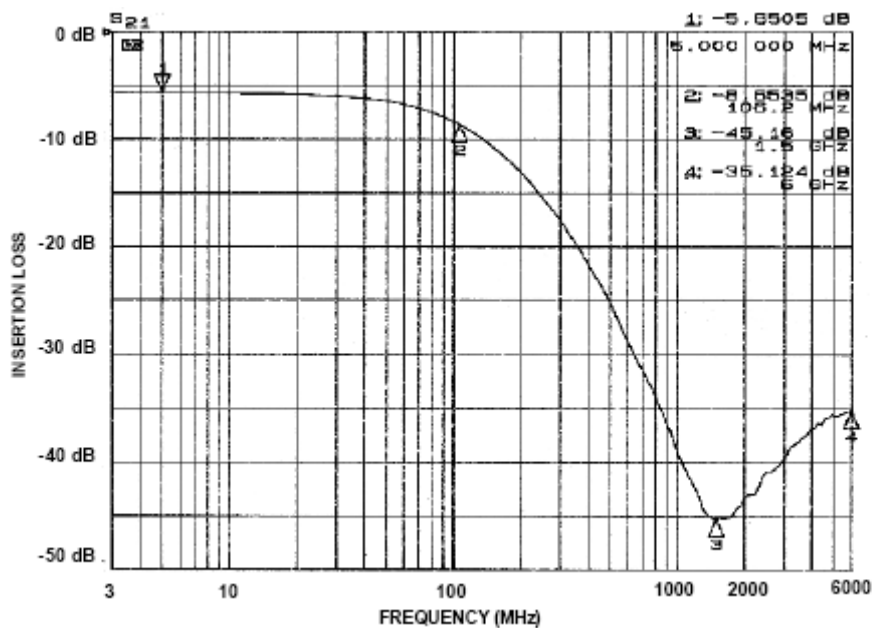

Figure 2. Insertion Loss vs. Frequency (FILTER2 Input to GND)

Performance Information (cont'd)

Typical Filter Performance ($T_A=25^\circ\text{C}$, DC Bias=0V, 50 Ohm Environment)

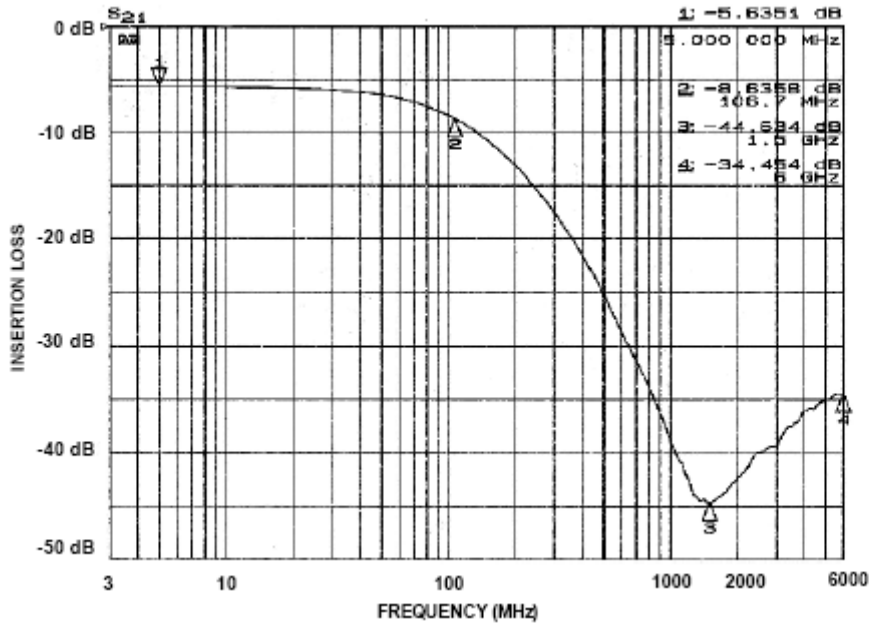

Figure 3. Insertion Loss vs. Frequency (FILTER3 Input to GND)

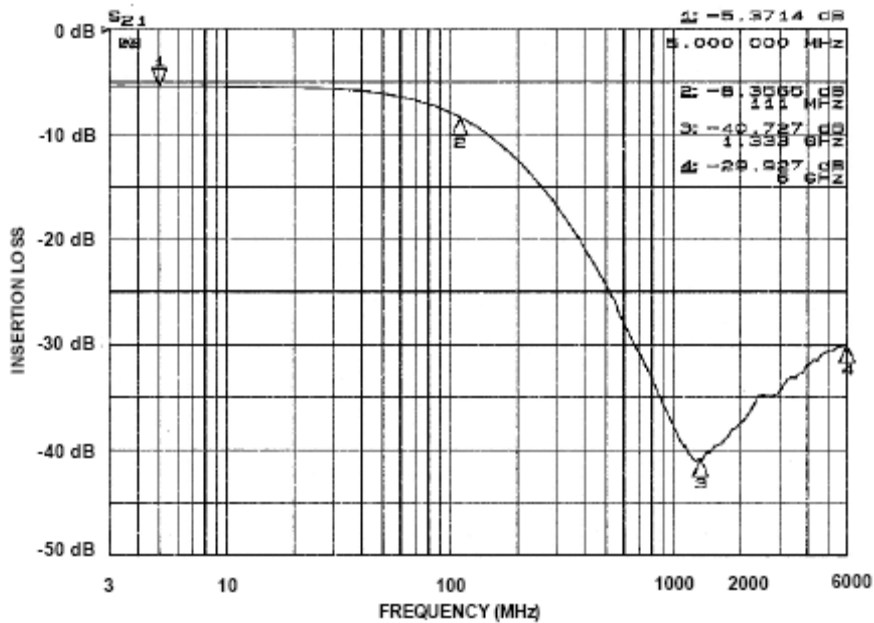

Figure 4. Insertion Loss vs. Frequency (FILTER4 Input to GND)

Performance Information (cont'd)

Typical Diode Capacitance vs. Input Voltage

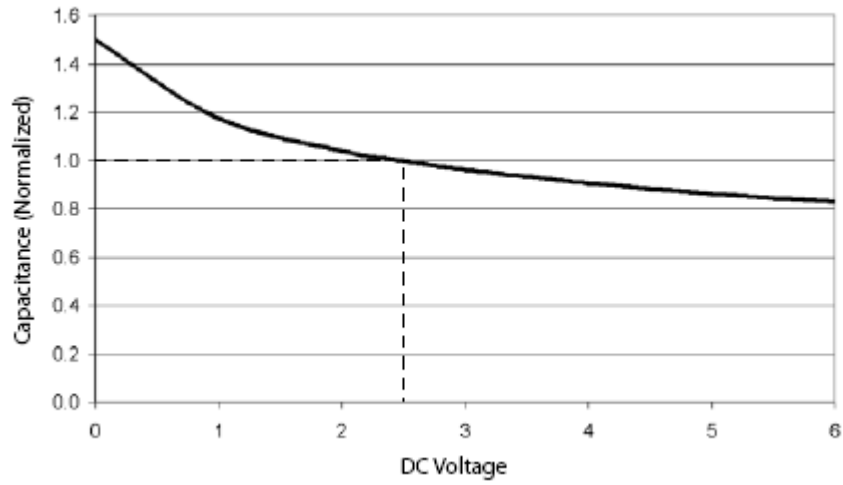

Figure 5. Filter Capacitance vs. Input Voltage (normalized to capacitance at 2.5VDC and 25°C)

CM1409

Mechanical Details

TDFN-12 Mechanical Specifications

The CM1409-06DE is supplied in a 12-lead, 0.5mm pitch TDFN package. Dimensions are presented below.

PACKAGE DIMENSIONS						
Package	TDFN					
JEDEC No.	MO-229C					
Leads	12					
Dim.	Millimeters			Inches		
	Min	Nom	Max	Min	Nom	Max
A	0.70	0.75	0.80	0.028	0.030	0.031
A3	0.20 REF			0.008 REF		
b	0.20	0.25	0.30	0.008	0.010	0.012
D	2.90	3.00	3.10	0.114	0.118	0.122
D2	2.40	2.50	2.60	0.095	0.098	0.102
E	1.25	1.35	1.45	0.049	0.053	0.057
E2	0.35	0.40	0.45	0.014	0.016	0.018
e	0.50 BSC			0.020 BSC		
K	0.20			0.008		
L	0.20	0.25	0.30	0.008	0.010	0.012
# per tape and reel	3000 pieces					
Controlling dimension: millimeters						

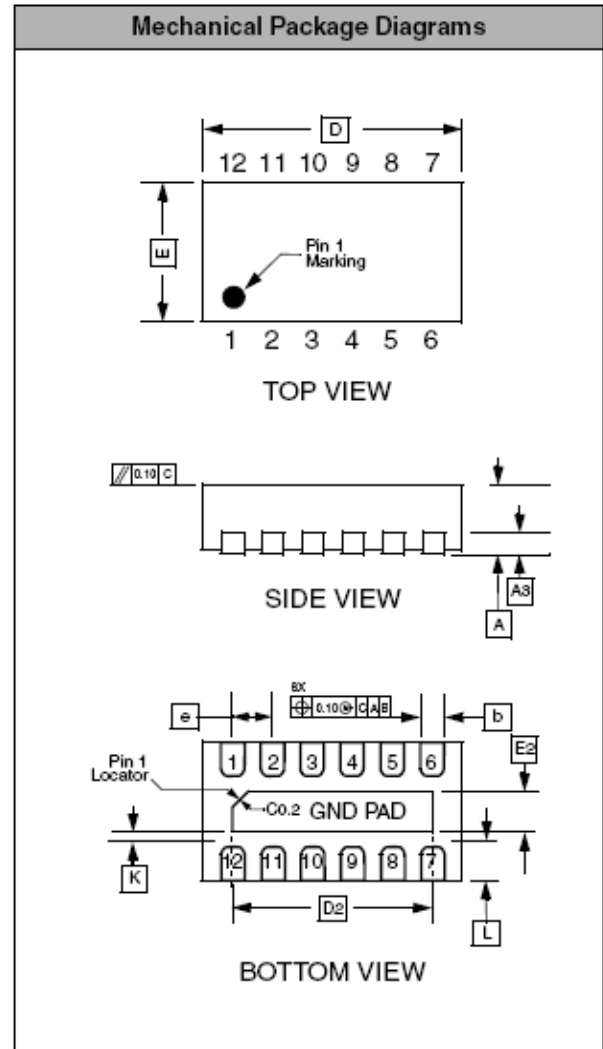

Dimensions for 12-Lead, 0.5mm pitch TDFN package

This package is compliant with JEDEC standard MO-229C with the exception of the "D", "D2", "E", "E2", "K" and "L" dimensions as called out in the table above.

Tape and Reel Specifications

PART NUMBER	PACKAGE SIZE (mm)	POCKET SIZE (mm) $B_o \times A_o \times K_o$	TAPE WIDTH W	REEL DIAMETER	QTY PER REEL	P_o	P_1
CM1409-06DE	3.00 X 1.35 X 0.75	3.30 X 1.65 X 1.05	8mm	178mm (7")	3000	4mm	4mm

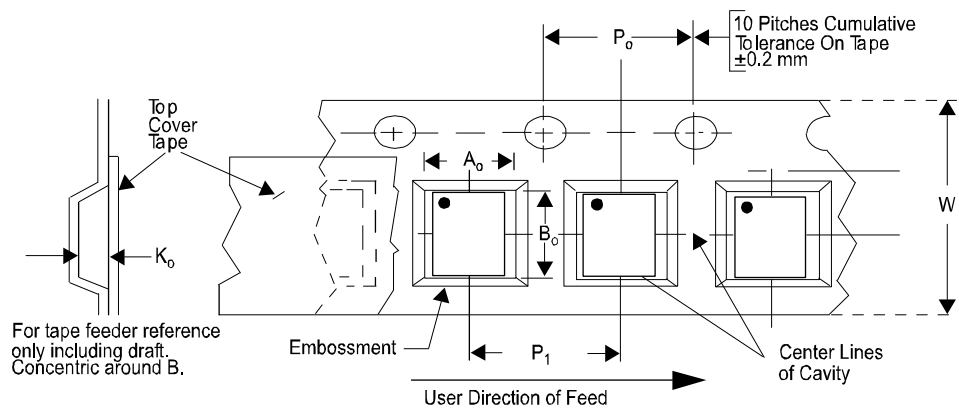

CM1409

Mechanical Details (cont'd)

TDFN-16 Mechanical Specifications

The CM1409-08DE is supplied in a 16-lead, 0.5mm pitch TDFN package. Dimensions are presented below.

PACKAGE DIMENSIONS						
Package	TDFN					
JEDEC No.	MO-229C					
Leads	16					
Dim.	Millimeters			Inches		
	Min	Nom	Max	Min	Nom	Max
A	0.70	0.75	0.80	0.028	0.030	0.031
A3	0.20 REF			0.008 REF		
b	0.20	0.25	0.30	0.008	0.010	0.012
D	3.90	4.00	4.10	0.153	0.157	0.161
D2	3.10	3.20	3.30	0.122	0.126	0.130
E	1.50	1.60	1.70	0.059	0.063	0.067
E2	0.30	0.40	0.50	0.012	0.016	0.020
e	0.50 BSC			0.020 BSC		
K	0.20			0.008		
L	0.20	0.30	0.40	0.008	0.010	0.012
M	0.25 REF			0.010 REF		
# per tape and reel	3000 pieces					
Controlling dimension: millimeters						

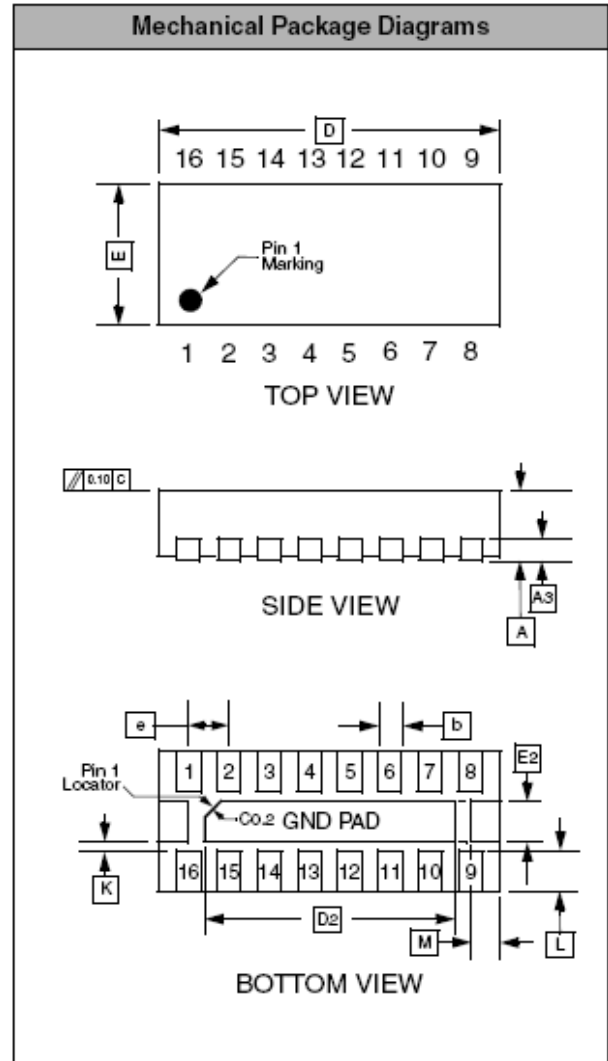



Dimensions for 16-Lead, 0.5mm pitch TDFN package

This package is compliant with JEDEC standard MO-229C with the exception of the "D", "D2", "E", "E2", "K" and "L" dimensions as called out in the table above.

Tape and Reel Specifications

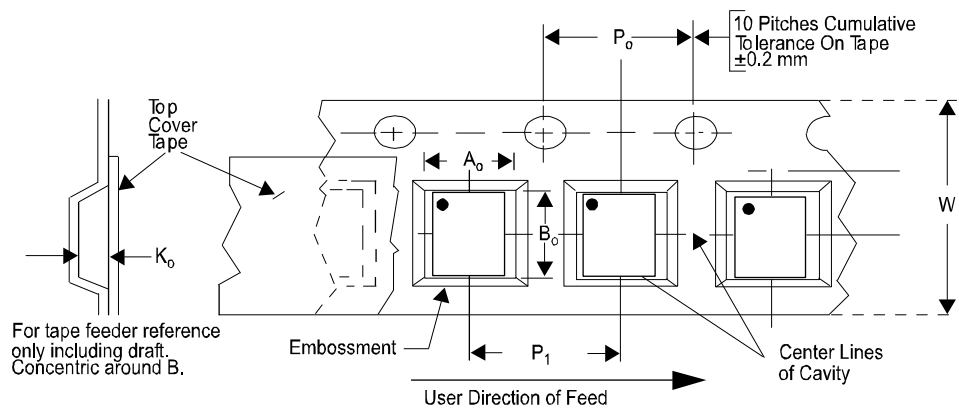
PART NUMBER	PACKAGE SIZE (mm)	POCKET SIZE (mm) $B_o \times A_o \times K_o$	TAPE WIDTH W	REEL DIAMETER	QTY PER REEL	P_o	P_1
CM1409-08DE	4.00 X 1.60 X 0.75	4.30 X 1.90 X 1.20	12mm	178mm (7")	3000	4mm	4mm



ON Semiconductor and  are registered trademarks of Semiconductor Components Industries, LLC (SCILLC). SCILLC reserves the right to make changes without further notice to any products herein. SCILLC makes no warranty, representation or guarantee regarding the suitability of its products for any particular purpose, nor does SCILLC assume any liability arising out of the application or use of any product or circuit, and specifically disclaims any and all liability, including without limitation special, consequential or incidental damages. "Typical" parameters which may be provided in SCILLC data sheets and/or specifications can and do vary in different applications and actual performance may vary over time. All operating parameters, including "Typicals" must be validated for each customer application by customer's technical experts. SCILLC does not convey any license under its patent rights nor the rights of others. SCILLC products are not designed, intended, or authorized for use as components in systems intended for surgical implant into the body, or other applications intended to support or sustain life, or for any other application in which the failure of the SCILLC product could create a situation where personal injury or death may occur. Should Buyer purchase or use SCILLC products for any such unintended or unauthorized application, Buyer shall indemnify and hold SCILLC and its officers, employees, subsidiaries, affiliates, and distributors harmless against all claims, costs, damages, and expenses, and reasonable attorney fees arising out of, directly or indirectly, any claim of personal injury or death associated with such unintended or unauthorized use, even if such claim alleges that SCILLC was negligent regarding the design or manufacture of the part. SCILLC is an Equal Opportunity/Affirmative Action Employer. This literature is subject to all applicable copyright laws and is not for resale in any manner.

PUBLICATION ORDERING INFORMATION

LITERATURE FULFILLMENT:

Literature Distribution Center for ON Semiconductor
P.O. Box 5163, Denver, Colorado 80217 USA
Phone: 303-675-2175 or 800-344-3860 Toll Free USA/Canada
Fax: 303-675-2176 or 800-344-3867 Toll Free USA/Canada
Email: orderlit@onsemi.com

N. American Technical Support: 800-282-9855
Toll Free USA/Canada
Europe, Middle East and Africa Technical Support:
Phone: 421 33 790 2910
Japan Customer Focus Center
Phone: 81-3-5773-3850

ON Semiconductor Website: www.onsemi.com

Order Literature: <http://www.onsemi.com/orderlit>

For additional information, please contact your local Sales Representative